

# SeeSnake<sup>®</sup> DVDPak

**OLED****LCD**

## **⚠ WARNING!**

Read this Operator's Manual carefully before using this tool. Failure to understand and follow the contents of this manual may result in electrical shock, fire and/or serious personal injury.

Trade Tool is an Authorized Service Center and a  
Ridgid Pro Platinum distributor  
[www.tradetoolsupply.com](http://www.tradetoolsupply.com)  
503.221.8665

Rental units available

## Table of Contents

Recording Form for Machine Serial Number .....	1
Safety Symbols.....	2
<b>General Safety Rules</b>	
Work Area Safety .....	2
Electrical Safety .....	2
Personal Safety .....	2
Equipment Use and Care.....	3
Battery Use and Care .....	3
Service .....	3
<b>Specific Safety Information</b> .....	3
DVDPak Safety .....	4
<b>Description, Specifications and Standard Equipment</b>	
Description .....	4
Specifications.....	5
Standard Equipment .....	5
Optional Equipment .....	5
<b>DVDPak Components</b> .....	5
DVDR Button Controls.....	5
<b>Pre-Operation Inspection</b> .....	6
<b>Work Area and Equipment Set Up</b> .....	6
DVDPak Placement .....	6
Connecting The DVDPak.....	7
Connection Icons .....	7
Powering The SeeSnake DVDPak .....	7
Monitor And DVDR Power-up .....	8
<b>DVDPak Settings</b> .....	9
<b>DVDPak Controls</b> .....	10
Keypad Controls .....	10
DVDR Button Controls.....	10
DVDPak Display Icons.....	10
<b>Operating Instructions</b> .....	11
Starting Up .....	11
Inspecting The Line .....	11
Recording An Inspection .....	12
Playing Back Recorded Video .....	13
Locating The Camera Using The Sonde .....	13
Line Tracing The SeeSnake Push Cable.....	13
<b>Maintenance Instructions</b> .....	14
Cleaning.....	14
<b>Accessories</b> .....	14
<b>Transport And Storage</b> .....	14
<b>Service And Repair</b> .....	14
<b>Disposal</b> .....	14
<b>Battery Disposal</b> .....	15
<b>Troubleshooting</b> .....	16
<b>Lifetime Warranty</b> .....	Back Cover

# SeeSnake® DVD Pak

## SeeSnake® DVD Pak



OLED

LCD



### SeeSnake® DVD Pak

Record Serial Number below and retain product serial number which is located on nameplate.

Serial  
No.

--	--

## Safety Symbols

In this operator’s manual and on the product, safety symbols and signal words are used to communicate important safety information. This section is provided to improve understanding of these signal words and symbols.

 This is the safety alert symbol. It is used to alert you to potential personal injury hazards. Obey all safety messages that follow this symbol to avoid possible injury or death.

 **DANGER** DANGER indicates a hazardous situation which, if not avoided, will result in death or serious injury.

 **WARNING** WARNING indicates a hazardous situation which, if not avoided, could result in death or serious injury.

 **CAUTION** CAUTION indicates a hazardous situation which, if not avoided, could result in minor or moderate injury.

**NOTICE** NOTICE indicates information that relates to the protection of property.



This symbol means read the operator’s manual carefully before using the equipment. The operator’s manual contains important information on the safe and proper operation of the equipment.



This symbol means always wear safety glasses with side shields or goggles when handling or using this equipment to reduce the risk of eye injury.



This symbol indicates the risk of electrical shock.

## General Safety Rules

### **WARNING**

Read all safety warnings and instructions. Failure to follow the warnings and instructions may result in electric shock, fire and/or serious injury.

### **SAVE ALL WARNINGS AND INSTRUCTIONS FOR FUTURE REFERENCE!**

#### Work Area

- **Keep work area clean and well lit.** Cluttered or dark areas invite accidents.
- **Do not operate equipment in explosive atmospheres, such as in the presence of flammable liquids, gases, or dust.** Equipment can create sparks which may ignite the dust or fumes.
- **Keep children and by-standers away while operating equipment.** Distractions can cause you to lose control.

#### Electrical Safety

- **Avoid body contact with earthed or grounded surfaces such as pipes, radiators, ranges and refrigerators.** There is an increased risk of electrical shock if your body is earthed or grounded.
- **Do not expose equipment to rain or wet conditions.** Water entering equipment will increase the risk of electrical shock.
- **Do not abuse the cord. Never use the cord for carrying, pulling or unplugging the equipment.**

**Keep cord away from heat, oil, sharp edges or moving parts.** Damaged or entangled cords increase the risk of electric shock.

- **If operating equipment in a damp location is unavoidable, use a ground fault circuit interrupter (GFCI) protected supply.** Use of a GFCI reduces the risk of electric shock.
- **Keep all electrical connections dry and off the ground. Do not touch equipment or plugs with wet hands.** This reduces the risk of electrical shock.

#### Personal Safety

- **Stay alert, watch what you are doing and use common sense when operating equipment. Do not use equipment while you are tired or under the influence of drugs, alcohol or medication.** A moment of inattention while operating equipment may result in serious personal injury.
- **Use personal protective equipment. Always wear eye protection.** Protective equipment such as dust mask, non-skid safety shoes, hard hat, or hearing protection used for appropriate conditions will reduce personal injuries.
- **Do not overreach. Keep proper footing and balance at all times.** This enables better control of the equipment in unexpected situations.
- **Dress properly. Do not wear loose clothing or jewelry. Keep your hair, clothing, and gloves away from moving parts.** Loose clothes, jewelry, or long hair can be caught in moving parts.

## Equipment Use and Care

- **Do not force equipment. Use the correct equipment for your application.** The correct equipment will do the job better and safer at the rate for which it is designed.
- **Do not use equipment if the switch does not turn it ON and OFF.** Any equipment that cannot be controlled with the switch is dangerous and must be repaired.
- **Disconnect the plug from the power source and/or the battery pack from the equipment before making any adjustments, changing accessories, or storing.** Such preventive safety measures reduce the risk of injury.
- **Store idle equipment out of the reach of children and do not allow persons unfamiliar with the equipment or these instructions to operate the equipment.** Equipment can be dangerous in the hands of untrained users.
- **Maintain equipment.** Check for misalignment or binding of moving parts, missing parts, breakage of parts and any other condition that may affect the equipment's operation. If damaged, have the equipment repaired before use. Many accidents are caused by poorly maintained equipment.
- **Use the equipment and accessories in accordance with these instructions, taking into account the working conditions and the work to be performed.** Use of the equipment for operations different from those intended could result in a hazardous situation.
- **Use only accessories that are recommended by the manufacturer for your equipment.** Accessories that may be suitable for one piece of equipment may become hazardous when used with other equipment.
- **Keep handles dry and clean; free from oil and grease.** Allows for better control of the equipment.

## Battery Tool Use And Care

- **Recharge only with the charger specified by the manufacturer.** A charger that is suitable for one type of battery pack may create a risk of fire when used with another battery pack.
- **Use equipment only with specifically designated battery packs.** Use of any other battery packs may create a risk of injury and fire.
- **Do not probe battery with conductive objects. When battery pack is not in use, keep it away from other metal objects, like paper clips, coins, keys, nails, screws or other small metal objects that can make a connection from one terminal to**

**another.** Shorting the battery terminals together may cause burns or a fire.

- **Under abusive conditions, liquid may be ejected from the battery; avoid contact. If contact accidentally occurs, flush with water. If liquid contacts eyes, additionally seek medical help.** Liquid ejected from the battery may cause irritation or burns.
- **Use and store batteries and chargers in dry, appropriate temperature areas.** Extreme temperatures and moisture can damage batteries and result in leakage, electrical shock, fire or burns. *See charger manual for more information.*
- **Do not cover charger while in use.** Proper ventilation is required for correct operation. Covering charger in use could result in fire.
- **Properly dispose of batteries.** Exposure to high temperatures can cause the batteries to explode, so do not dispose of in a fire. Some countries have regulations concerning battery disposal. Please follow all applicable regulations.

## Service

- **Have your equipment serviced by a qualified repair person using only identical replacement parts.** This will ensure that the safety of the equipment is maintained.
- Remove the batteries and refer servicing to qualified service personnel under any of the following conditions:
  - If liquid has been spilled or objects have fallen into product;
  - If product does not operate normally by following the operating instructions;
  - If the product has been dropped or damaged in any way; or,
  - When the product exhibits a distinct change in performance.

## Specific Safety Information

### **WARNING**

This section contains important safety information that is specific to this equipment.

Read these precautions carefully before using the DVD Pak to reduce the risk of electrical shock or other serious personal injury.

### **SAVE THESE INSTRUCTIONS!**

Keep this manual with the machine for use by the operator.

If you have any question concerning this Ridge Tool product:

- Contact your local RIDGID® distributor.
- Visit [www.RIDGID.com](http://www.RIDGID.com) or [www.RIDGID.eu](http://www.RIDGID.eu) to find your local Ridge Tool contact point.
- Contact Ridge Tool Technical Services Department at [rttechservices@emerson.com](mailto:rttechservices@emerson.com), or in the U.S. and Canada call (800) 519-3456.

**DVDPak Safety**

- **An improperly grounded electrical outlet can cause electrical shock and or severely damage equipment.** Always check work area for a properly grounded electrical outlet. Presence of a three prong or GFCI outlet does not insure that the outlet is properly grounded. If in doubt, have the outlet inspected by a licensed electrician.
- **Power the DVDPak only with a specifically designated battery or a double insulated power supply.**
- **Do not operate this equipment if operator or machine is standing in water.** Operating machine while in water increases the risk of electrical shock.
- **The DVDPak is not waterproof. Only the camera and push cable are waterproof.** Do not expose the equipment to water or rain. This increases the risk of electrical shock.
- **Do not use where a danger of high voltage contact is present.** The equipment is not designed to provide high voltage protection and isolation.
- **Read and understand this operator’s manual, the reel operators’ manual, and the instructions for any other equipment in use and all warnings before operating the DVDPak.** Failure to follow all instruction may result in property damage and/or serious personal injury.
- **Always use appropriate personal protective equipment while handling and using equipment in drains.** Drains may contain chemicals, bacteria and other substances that may be toxic, infectious, cause burns or other issues. Appropriate personal protective equipment always includes safety glasses, and may include equipment such as drain cleaning gloves or mitts, latex or rubber gloves, face shields, goggles, protective clothing, respirators and steel toed footwear.
- **If using drain cleaning equipment at the same time as using drain inspection equipment, only wear RIDGID Drain Cleaning Gloves.** Never grasp the rotating drain cleaning cable with anything else, including other gloves or a rag. They can become wrapped around the cable, causing hand injuries. Only wear

latex or rubber gloves under RIDGID Drain Cleaner Gloves. Do not use damaged drain cleaning gloves.

- **Practice good hygiene.** Use hot, soapy water to wash hands and other exposed body parts exposed to drain contents after handling or using drain inspection equipment. Do not eat or smoke while operating or handling drain inspection equipment. This will help prevent contamination with toxic or infectious material.

For detailed instructions on the operation of the Sony® DVDR unit, see the manual provided by the unit’s manufacturer.

**Description, Specifications And Standard Equipment**

**Description**

The SeeSnake® DVDPak is a robust, lightweight weather-resistant camera monitor, control and recording unit for use with a SeeSnake Pipe Inspection System. Combined with the Sony® Multi-Function Digital Video Disc Recorder (DVDR), the DVDPak can be used to monitor, record and store video in convenient DVD format.

The DVDPak is designed to easily connect with a SeeSnake reel and camera and monitor and record the view from the camera. It can also be used with a SeeSnake Pipe Inspection System with a separate monitor, to record pipe inspection views to DVD. It provides readily accessible controls for using the Sony Multi-Function recorder, while protecting the recorder in a durable, easily portable case.

Other auxiliary equipment used with the SeeSnake DVDPak may include:

- Rechargeable battery.
- A RIDGID locator/receiver (such as the SR-20, the SR-60, the Scout™ or the NaviTrack® II).
- A RIDGID transmitter (such as the ST-510, the ST-305, the NaviTrack® Brick or the NaviTrack® 10-watt transmitter).
- The CountPlus Cable Counter cable-measurement system, normally built in to SeeSnake pipe inspection systems.

**Specifications**

Weight (with DVDR) .....9.25 lbs (4.2kg) w/o Battery  
 10.65 lbs. (4.8 kg) with Battery  
 Weight (w/o DVDR) .....5.75 lbs (2.6 kg) w/o Battery  
 7.15 lbs. (3.2 kg) with Battery

**Dimensions (Closed):**

- Length .....(35 cm) w/o Battery
- Width .....9.1" (23 cm)
- Height .....5.3" (13'4 cm)
- Power Source ..... 100-240VAC/50-60Hz, AC or  
18 VDC Rechargeable Battery
- Battery Type ..... 1 x 18 V Li-Ion, 2.2 Ah
- Power Rating ..... 14-16VDC 40W  
12 VDC 30 W (DVDR Only)

**Operating Environment:**

- Temperature .....40°F to 95°F (5°C to 35°C)
- Humidity .....5% to 95% RH
- Storage Temperature ....-4°F to 158°F (-20°C to 70°C)
- Altitude ..... 13120 feet (4000 meters)

- Display .....4.3" OLED (10.9 cm) or  
5.7 LCD (14.47 cm)
- Resolution ..... 480 x 272 (OLED)  
320 x 240 (LCD)

**Operating temperature ranges for Display Only operation (not using the DVDR):**

- 4.3" OLED Display .....-40°F to 185°F (-40°C to 85°C)
- 5.7" LCD Display .....-4°F to 158°F (-20°C to 70°C)

**Standard Equipment**

- DVD Pak
- 100-220VAC to 15VDC Power Converter and Supply
- Operator's Manual
- Sony VRD-MC5 Digital Video Disc Recorder (DVDR)
- Instructional DVD
- RCA Cable
- Shoulder Strap
- Sony DVDR Operator's Manual

**Optional Equipment**

	Cat # (US)	Cat # (EU)
18 V Li-Ion Rechargeable Battery	32743	28218
Battery Charger	32068	32073
Dual Battery Kit with Charger	32648	32693
Single Battery Kit with Charger	32708	32713

The DVD Pak is protected under U.S. and international patents and patents pending.

**DVD Pak Components**



Figure 1 – DVD Pak Components

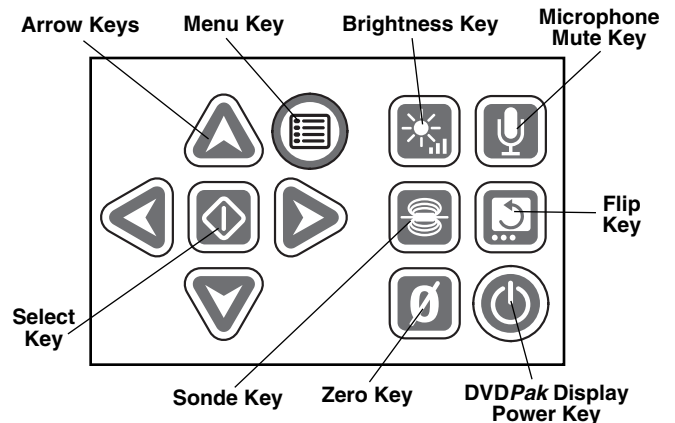

Figure 2 – DVD Pak Keypad

**DVDR Button Controls**

- Return Button:** Brings up the Sony DVDR Menu.
- Power Button:** Turns the DVD Pak system ON or OFF. Also controls display power.
- Record Button:** Starts the Sony DVDR recording.
- Arrow Buttons:** Highlight a menu selection.
- Enter/Select Button:** Chooses a highlighted menu option.
- Stop Button:** Stops recording or playback.
- Eject Button:** Opens the disc tray.

## Pre-Operation Inspection

**⚠ WARNING**



**Before each use, inspect your SeeSnake DVDPak and correct any problems to reduce the risk of serious injury from electrical shock or other causes and prevent machine damage.**

1. Confirm that the power is off, any external power and cords are disconnected, and the battery is removed. Inspect the cords, cables and connectors for damage or modification.
2. Clean any dirt, oil or other contamination from the SeeSnake DVDPak to aid in inspection and to prevent the unit from slipping from your grip while transporting or using.
3. Inspect the DVDPak for any broken, worn, missing, misaligned or binding parts, or any other condition which might prevent safe, normal operation.
4. Inspect any other equipment being used per its instructions to make sure it is in good usable condition.
5. If any problems are found, do not use the unit until the problems are corrected.

## Work Area and Equipment Set Up

**⚠ WARNING**



**Set up the DVDPak and work area according to these procedures to reduce the risk of injury from electrical shock, fire, and other causes, and to prevent damage to the DVDPak.**

1. Check work area for:
  - Adequate lighting.

- Flammable liquids, vapors or dust that may ignite. If present, do not work in area until sources have been identified and corrected. The DVDPak is not explosion proof. Electrical connections can cause sparks.
  - Clear, level, stable dry place for operator. Do not use the machine while standing in water.
  - Clear path to electrical outlet, that does not contain any potential sources of damage for the power cord, when using external power.
2. Inspect the work to be done. If possible, determine the drain access point(s), size(s) and length(s), presence of drain cleaning chemicals or other chemicals, etc. If chemicals are present, it is important to understand the specific safety measures required to work around those chemicals. Contact the chemical manufacturer for required information.
  3. Determine the correct equipment for the application. The SeeSnake DVDPak is made to view and record inspections done with an inspection camera. Inspection equipment for other applications can be found by consulting the Ridge Tool Catalog, online at [www.RIDGID.com](http://www.RIDGID.com) or [www.RIDGID.eu](http://www.RIDGID.eu).
  4. Make sure all equipment has been properly inspected.
  5. Evaluate the work area and determine if any barriers are needed to keep bystanders away. Bystanders can distract the operator during use. If working near traffic, erect cones or other barriers to alert drivers.
  6. If needed, remove fixture (water closet, sink, etc.) to allow access.

### DVDPak Placement

Open the DVDPak sunshade and display and place it to allow easy access and viewing while manipulating the camera and pushrod for an inspection. Make sure that the location is not wet and will not let the DVDPak and other equipment get wet during use. The DVDPak is not waterproof and exposure to wet conditions can cause electrical shock or equipment damage.

Place camera and reel as instructed in their Operator's Manual. Ensure the DVDPak and cable reel are stable.

## Connecting the DVDPak

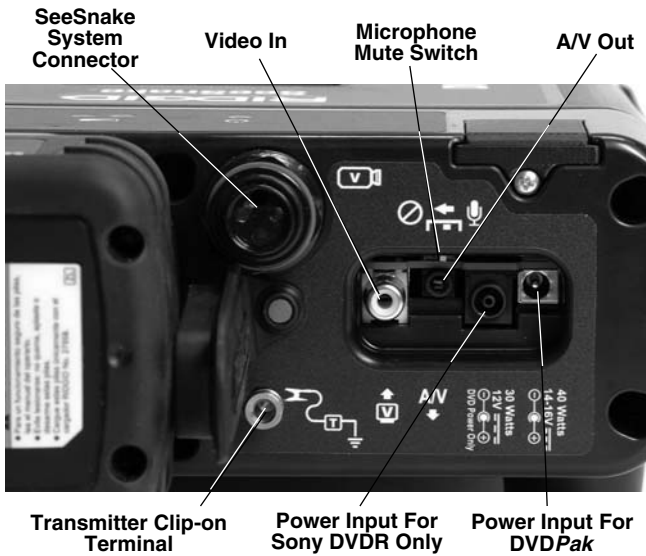

Figure 3 – DVDPak Connections

## Connection Icons

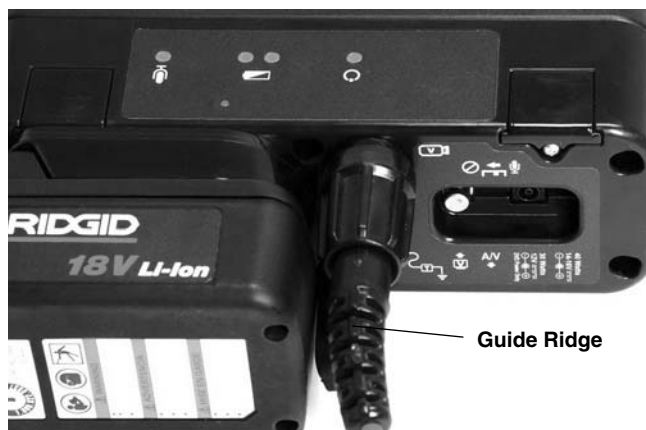
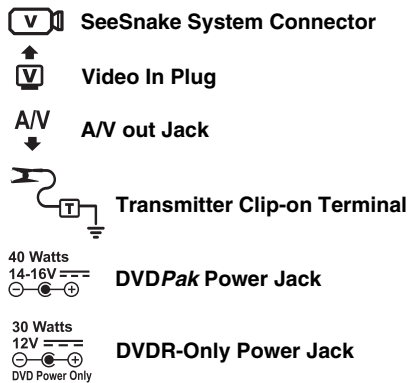

Figure 4 – Connecting System Plug to DVDPak System Connector



**NOTICE** When connecting/disconnecting the SeeSnake system cable, turn only the locking sleeve. To prevent damage, do not bend or twist the connector or cable.

## SeeSnake System Cable

Unwrap the SeeSnake System Cable from its holder and match the System Cable plug to the matching SeeSnake System Connector on the DVDPak. To join the connectors, align the guide pin to the guide socket, push the connector straight in and tighten the outer locking sleeve.

**NOTE!** A guide ridge molded into the top of the cable connector will point up when the plug is correctly aligned.

## External Monitor Options

1. The DVDPak may be used with an external SeeSnake monitor by connecting an RCA cable found in the pouch attached to the shoulder strap, from the Video Out port on the monitor. Connect the other end of the cable to the yellow DVDPak video input port on the back of the DVDPak, marked with .
2. The A/V out port  will pass through live video from the camera and live audio from the microphone out to another DVDR or monitor. (If connected to a monitor which has speakers it may cause a feedback squeal; this can be prevented by muting the microphone with the Mute Switch).

The A/V out port does not transmit recorded video or audio output from the Sony DVDR.



Figure 5 – DVDPak with SeeSnake

## Powering The SeeSnake DVDPak

The SeeSnake DVDPak can either be powered with RIDGID Li-Ion rechargeable battery or plugged in to an outlet using a supplied AC/DC power converter. Battery power is the preferred powering method to reduce the risk of electrical shock. **Additionally, the power converter is not rated for outdoor use and should only be used indoors.**

**Battery Power**

With dry hands, slide a fully charged battery onto the battery dock on the back of the DVDPak.



**Figure 6 – Battery Installed**

Make sure that the battery locks onto the dock. See the Battery Charger operator’s manual for more information.

Batteries supplied for the DVDPak are rated at 2.2 amp-hours. When fully charged, depending on use (recording time, etc.) the DVDPak will run for approximately 2.5 to 3 hours. Battery Status LED’s indicate battery charge level (Figure 7). See Battery Status LEDs Chart.



**Figure 7 – Battery Status LEDs**

**Battery Status LEDs Chart**

Battery Status	External Power Not Connected	External Power Connected
FULL	Solid green	Green blinking (5 sec OFF 0.2 ON)
MED	Solid green and red	Green and red blinking (5 sec OFF 0.2 ON)
LOW	Solid red, 4 beeps	Red blinking (5 sec OFF 0.2 ON)
DEAD	Solid red for 5 sec, 5 sec long beep and shutdown	

**Outlet Power**

For plug in operation, a double insulated AC/DC power supply is supplied to reduce wall outlet voltage to the correct voltage for the DVDPak.

**NOTICE** The external power supply is intended for indoor use only.



To power the system up with the power cord, locate the power supply. The power supply cord has two sections, one of which plugs into a standard 110-120V two-bladed outlet (US) at one end and plugs into a power supply at the other end. The second section runs from the power supply to the back of the DVDPak and plugs into the jack marked [40 Watts—14-16V] at the far right side of the back of the unit (Figure 8).





**Figure 8 – Connected External Power Supply**

With dry hands, connect the two sections together and insert the jack plug into the jack on the back of the DVDPak. Route the cord along a clear path and with dry hands plug the power supply into a matching outlet. If using an extension cord ensure it is of adequate wire gauge. For cords of 25 feet, a minimum gauge of 18AWG is required. For cords greater than 25 feet, a minimum gauge of 16 AWG is required.

**Monitor And DVDR Power-up**

Once connections are in place and batteries installed (if used), you can power up the DVD Recorder and the DVDPak monitor with a single press of the Power Button . You can also power the monitor independently by pressing the Power Key  on the keypad. This lets you use the monitor without powering up the recorder to conserve battery power.







**If you power the monitor on separately using the display Power Key , remember to turn it off using the display Power Key. If you power the monitor and DVDR up by pressing the DVDR Power Button , use the DVDR Power Button to turn the unit OFF.**

## DVDPak Settings

The following settings may need to be checked or modified depending on where and how you are using the DVDPak.





### Video Display Setting

If you do not see the camera view in the display, you may need to do the following (Figure 9):

1. Press Return Button . A menu will appear.
2. Using the Arrow Buttons   highlight the Video  DVD option and press the Enter button.
3. Using the Arrow Buttons   highlight the VIDEO IN option and press the Enter button.





These steps inform the unit of the correct source for display.

### Auto-Chapter Setting

The Auto-Chapter setting will serve best if it is set to "OFF", meaning that the recorder will start a new chapter each time you pause the recording. To do this, press the Return Button  to access the Main Menu and select "Setup". Arrow down to Auto-Chapter and press Enter . Toggle the setting to "OFF" using the Arrow Buttons   and press Enter .

### NTSC/PAL Video Setting





It may be necessary to set your recorder to format discs to the same color format as the camera is sending it. The Color System options are NTSC (U.S.) or PAL (Europe). The unit will not record if the color system conflicts with the disc format. To set the Color System option:

1. Press the Return button  to access the main menu.
2. Press the Arrows   to highlight **Setup** and press Enter to bring up the **Setup** Menu.
3. Arrow down to **Color System** and press Enter.
4. Use the Arrow Buttons   to highlight the correct color system (NTSC for U.S. and PAL for Europe, for example).
5. Press Return to go up to the Main Menu, and repeat steps 2 and 3 of Video Display Setting (on page 9).

**The setting that is in place in the setup menu at the time of formatting the disc determines the disc's format. You can display either PAL or NTSC input on the DVDPak, regardless of how the "Color System" is set in the Sony Unit. However, after you have formatted a DVD, you can only record in the color system that was in effect when the disc was formatted.**







### Units Setting

The DVDPak can be set to display distance in meters or feet, or to allow the setting to be selected automatically. (This applies to SeeSnake systems equipped with CountPlus digital distance counters only.) To set the unit option:

1. With the DVDPak powered on, press the Menu Key .
2. Use the Arrow Keys  to scroll down to **Unit**.
3. Use the Select Key  to move from Feet to Meters or Auto.
4. When the choice you prefer is highlighted, simply press the Menu Key  again to close the menu.

### Color Setting

The DVDPak display can be adjusted for greater color density in the display. To adjust the color:

1. With the DVDPak powered on and connected to a See Snake camera, press the Menu Key .
2. If the Color option is not highlighted on the Menu, use the Arrow Keys   to scroll to the Color option.
3. Use the Arrow Keys   to adjust the color to your preference.
4. When the display suits your requirements, simply press the Menu Key  again to close the menu.

### Contrast and Brightness Setting

Use the same steps shown under Color Setup to adjust the Contrast and Brightness settings of the display. Note that you may want to adjust these again during the inspection depending on light and color conditions inside the pipe. You can also access the Brightness control directly simply by pressing the Brightness Key .

## DVDPak Controls

### Keypad Controls

















-  **Arrow Keys:** Used to move among menu choices and adjust variables (such as contrast) up and down.
-  **Select Key:** Used to choose options in the Units menu (Auto, Meters and Feet).
-  **Menu Key:** Used to bring up a menu of display options such as Color, Brightness, Contrast, Units.
-  **Brightness Key:** Used to directly control the camera LED's brightness up or down.
-  **Microphone Mute Key:** Used to mute the microphone while recording or activate it to record comments during an inspection.
-  **Sonde Key:** Used to activate the built-in Sonde for tracing the location of the camera head.
-  **Flip Key:** Used to flip the image on the display vertically (5.7" LCD display only).
-  **Zero Key:** Used to establish a temporary zero-point for the distance counter for units equipped with the CountPlus.
-  **Display Power Key:** Used to power the DVDPak display on or off. Does not control DVDR power.



Figure 9 – DVDPak Controls

### DVDR Button Controls

-  **Return Button:** Brings up the Sony DVDR Menu.
-  **Power Button:** Turns the DVDPak system ON or OFF. Also controls display power.
-  **Record Button:** Starts the Sony DVDR recording.
-  **Arrow Buttons:** Highlight a menu selection.
-  **Enter/Select Button:** Chooses a highlighted menu option.
-  **Stop Button:** Stops recording or playback.
-  **Eject Button:** Opens the disc tray.

### DVDPak Display Icons





-  **Battery Level:** Indicates the charge state of the battery.
-  **Microphone Off:** Appears when the microphone has been switched OFF.
-  **Sonde:** Appears when the Sonde is switched ON.
-  **Brightness Control:** Appears when adjusting the display brightness.



Figure 10 – DVDR Buttons

## Operating Instructions

### ⚠ WARNING





Always wear eye protection to protect your eyes against dirt and other foreign objects.

When inspecting drains that might contain hazardous chemicals or bacteria, wear appropriate protective equipment, such as latex gloves, goggles, face shields or respirators, to prevent burns and infections.

Do not operate this equipment if operator or machine is standing in water. Operating machine while in water increases the risk of electrical shock. Rubber soled, non-slip shoes can help prevent slipping and electric shock, especially on wet surfaces.

Follow operating instructions to reduce the risk of injury from electrical shock and other causes.

### Starting Up

1. Check the unit is properly set up.
2. Connect the DVD Pak either to the SeeSnake camera directly or to an external SeeSnake monitor using the RCA cable.
3. Place the camera head into the reel's guide hoop and turn the DVD Pak's power on .
4. If there is a disc in the DVD tray, the system will do a disc check. It will ask for a disc if none is found.
5. To insert a disc, press the Eject button  and insert a blank DVD-R or DVD-RW into the tray. Close the tray by pressing the Eject Button.

**NOTICE** Make sure the plug seal is opened before ejecting the disc tray. This will avoid damaging the tray mechanism.

6. If the system finds an unformatted disc it will ask permission to format it. Press RETURN  to format. The unit will not record to an unformatted disc.
7. Close the DVD Pak disc tray front plug seal to protect against dust and moisture.



Figure 11 – DVD Tray Open

Once a formatted disc is detected, the camera view should appear on both the DVDR screen and the DVD Pak monitor. If you do not see the camera view on the display, the source for the display needs to be changed. (See *Video Display Settings* on page 9.)







Figure 12 – Camera Image Display On DVDR Screen

### Inspecting The Line

1. Power up the DVD Pak if it is off.
2. Put the camera head in the line.
3. Proceed with pipe inspection as described in your SeeSnake manual.

### Brightness Adjustment

You may find you need to increase or decrease the camera LED brightness while inspecting the inside of a

line, depending on conditions. To do so simply press the Brightness Key  and raise or lower the brightness level using the Arrow Key  . Press the Menu Key  when done.

**Image Rotation**

While doing an inspection the camera may become rotated in the line and present an inverted image. If you are using a DVDPak with a 5.7" LCD display, the Flip Key  will rotate the image on the screen (flip it vertically) for easier viewing. (This feature is not supported on the 4.3" OLED display.) The recorder will capture the image as it is displayed.

**CountPlus Control**

If you are using a SeeSnake reel equipped with the CountPlus distance counter, the measured distance will appear on the DVDPak display. If you want to set an interim zero-point to measure distance from some location (such as a junction or pipe-head) pressing the DVDPak Zero Key  will start a temporary distance count, with the number displayed in square brackets [0.0]. A second short press will return to the main count. A long press (3 seconds) will re-zero the main distance counter.

For details on using the CountPlus see the CountPlus manual. CountPlus parameters such as date and time are set using the CountPlus menu key and going to the CountPlus Tools menu. CountPlus text overlays are managed with the CountPlus keypad as described in the CountPlus Operator's Manual.

**Recording An Inspection**



When a new disc is inserted the DVDR will format the disc for recording, providing a camera is connected.



If necessary, follow the steps under Video Display Settings (page 9) to choose **Video In** as the input.

**NOTICE** Jogging or moving the unit during recording may physically damage the disc and cause the DVD to be unplayable. Losing power to the unit during recording will cause the loss of unsaved chapters.



**Basic Recording**

The basic technique for recording is straightforward.

1. Position the camera in the line where you would like to start recording.
2. Press the Record  button. The display will show "Recording". Audio is being recorded automatically through the built-in microphone unless it has been muted with the Microphone Mute Key  (See Figure 3.)

3. To PAUSE press the Record  button. Press it again to resume.
4. To STOP recording press the Stop button . After a brief pause to end the current chapter, the display will again show the present camera view with the amount of remaining recording time available on the current disc showing under it.

**Sound Recording**

The built-in microphone for DVDPak sound recording is located just to the right of the monitor display screen. In a windy or noisy environment you may prefer to have the microphone muted during an inspection while recording only the video from the camera. You may want to turn the microphone on to record comments during the inspection. To toggle the microphone on and off, simply press the Microphone Mute Key . An audio mute icon  will appear when the microphone is muted and will disappear when the microphone is active.

**Finalizing a Disc**

When using a DVD/R disc for recording, the DVD cannot be played back on any other unit until the DVD is finalized. Once a disc has been finalized, it cannot be recorded to again. A disc that has been finalized will show a row of selectable chapters on start up. RW discs do not require finalizing and can be added to

1. Once you have been prompted to finalize the disc, if you choose to finalize it, use the arrow buttons to highlight "Yes" and press Enter. (See Figure 13.) If you do not want to finalize the disc, highlight "No" with the Arrow Buttons and press the Enter Button.

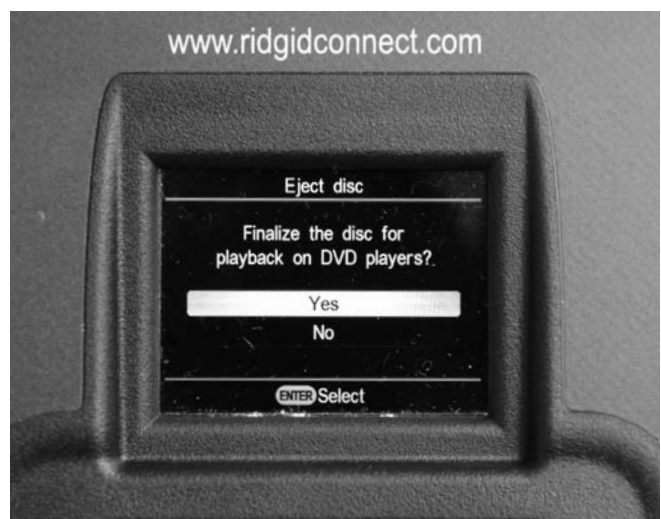

Figure 13 – "Finalize a Disc" Option

2. A notice will be displayed stating that after finalizing, no further recording is allowed. (See Figure 14.) Select "OK" to start finalizing.



Figure 14 – Finalization Warning

- The finalizing process may take several minutes depending on the amount of recorded material. Once finalizing is complete, the disc will eject.

Discs can also be finalized by pressing the Return Button, choosing Setup and then choosing Finalize from the menu.

### Playing Back Recorded Video

To play back a recorded chapter, press the RETURN ● button to bring up the Menu and highlight **DVD Preview**. Then press the Select button □.

If the disc has not been finalized, the last recorded video will appear and play back in the DVDR screen.

If the disc has been finalized, a series of thumbnails for the existing chapters recorded on the disc will be displayed. Highlight the one you want to play and press the Select button again to start it. (Audio will not be heard when previewing video on the DVD Pak but will play on a DVD player or computer if recorded.) To return to the recording mode, press the Return ● button to go back to the Menu and highlight Video → DVD. Press Select, highlight **Video In** and press Select again. The unit is now ready to record to either an RW or an un-finalized disc.

### Locating The Camera Using The Sonde

Many SeeSnake pipe inspection systems have a built-in Sonde which transmits a locatable 512 Hz signal. When the Sonde is turned on, a locator such as the RIDGID SR-20, SR-60, Scout™ or NaviTrack® II set to 512 Hz will be able to detect it, allowing you to detect the camera's location underground.

To turn the SeeSnake Sonde on while using the DVD Pak, press the Sonde Key ☒. A Sonde icon will appear on the display while the Sonde is on. The display may also show some lines of interference from the Sonde's transmission.

These will vanish when the Sonde is turned off by again pressing the Sonde Key ☒.

The most workable approach to tracking the Sonde is to run the pushrod into the pipe about five or ten feet (1.5 to 3 meters) and use the locator to find the Sonde's position. If desired, you can then extend the pushrod a similar distance further down-pipe and locate the Sonde again starting from the previous located position. To locate the Sonde, turn the locator on and set it to Sonde mode. Scan in the direction of the Sonde's probable location until the locator detects the Sonde. Once you have detected the Sonde, use the locator indications to zero in on its location precisely. For detailed instructions on Sonde locating, consult the Operator's Manual for the locator model you are using.

### Line Tracing The SeeSnake Push Cable

In addition to being able to trace a Sonde built into the system camera, the DVD Pak also enables you to trace the line of the SeeSnake push cable underground, using a standard RIDGID locator such as the NaviTrack® II, the Scout™, the SR-20 or the SR-60. To line-trace the SeeSnake push cable, simply connect a line transmitter with one connector well-grounded using the grounding stake, and the other connector clipped to the DVD Pak's Transmitter Clip-on Terminal. The Transmitter Clip-on Terminal is a metal lug located just to the right of the battery. (See Figure 3.)

Set the line transmitter and the locator to the same frequency, such as 33 kHz and use the locator to trace the line (Figure 15). The camera's built-in Sonde may be on at the same time, and if your locator is equipped with SimulTrace™ capability, you can follow the pushrod all the way to the camera's location and then detect the Sonde in the camera as you approach it above ground.

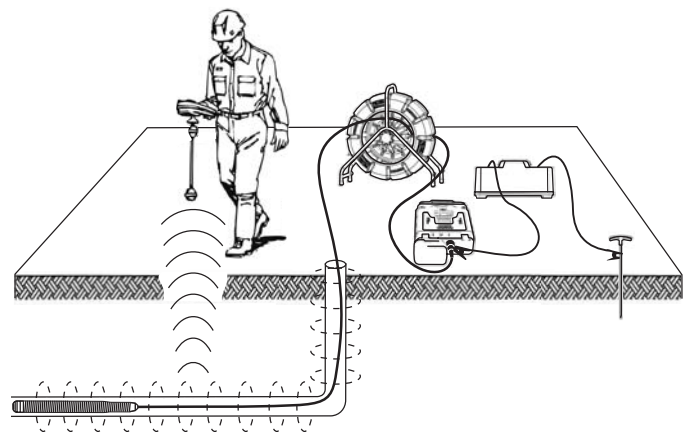

Figure 15 – Line Tracing the Pushrod

If you don't have the SimulTrace™ feature, use a line transmitter and a locator to line-trace the pushrod. When the signal fades, switch the locator to Sonde mode at the frequency of the in-line Sonde, usually 512 Hz. Pick the signal up from where the line-trace frequency started to weaken and zero in on the in-line Sonde. Because locating frequencies from transmitters can cause distortion of the image on the monitor, it is best to turn Sonde and line transmitters off while inspecting the interior of a line and turn them on only when ready to do a locate.

## Maintenance Instructions

### Cleaning

**⚠ WARNING**

**Make sure all cords and cables are disconnected and the battery removed prior to cleaning the DVDPak to reduce the risk of electrical shock.**

Do not use liquid or abrasive cleaners on the DVDPak. Clean the DVDPak with damp cloth. Only use cleaners approved for use on LCD screens to clean the screens. Do not allow any liquid to enter the DVDPak.

### Accessories

**⚠ WARNING**

**The following accessories have been designed to function with the DVDPak. Other accessories suitable for use with other equipment may become hazardous when used with the DVDPak. To reduce the risk of serious injury, only use accessories specifically designed and recommended for use with the DVDPak, such as those listed below.**

Catalog #		Description
US	EU	
32743	28218	18 V Li-Ion rechargeable battery
32068	32073	Battery charger
32648	32693	Dual battery kit with charger
32708	32713	Single battery kit with charger
Various		RIDGID SeekTech® or NaviTrack® Locator
Various		RIDGID SeekTech® or NaviTrack® Transmitters

## Transport And Storage

**Remove batteries before shipping.** Do not expose to heavy shocks or impacts during transport. If storing for an extended period, remove batteries. Store within temperature range of -4°F to 158°F (-20°C to 70°C).

Store electrical devices in a dry place to reduce the risk of electrical shock.

Protect against excessive heat. The unit should be situated away from heat sources such as radiators, heat registers, stoves or other products (including amplifiers) that produce heat.

## Service And Repair

**⚠ WARNING**

**Improper service or repair can make the DVDPak unsafe to operate.**

Service and repair of the DVDPak must be performed by a RIDGID Independent Authorized Service Center.

For information on your nearest RIDGID Independent Service Center or any service or repair questions:

- Contact your local RIDGID distributor.
- Visit [www.RIDGID.com](http://www.RIDGID.com) or [www.RIDGID.eu](http://www.RIDGID.eu) to find your local Ridge Tool contact point.
- Contact Ridge Tool Technical Services Department at [rttechservices@emerson.com](mailto:rttechservices@emerson.com), or in the U.S. and Canada call (800) 519-3456.

## Disposal

Parts of the unit contain valuable materials and can be recycled. There are companies that specialize in recycling that may be found locally. Dispose of the components in compliance with all applicable regulations. Contact your local waste management authority for more information.

**For EC Countries:** Do not dispose of electrical equipment with household waste!



According to the European Guideline 2002/96/EC for Waste Electrical and Electronic Equipment and its implementation into national legislation, electrical equipment that is no longer usable must be collected separately and disposed of in an environmentally correct manner.

## Battery Disposal



**For USA and Canada:** The RBRC™ (Rechargeable Battery Recycling Corporation) Seal on the battery packs means that RIDGID has already paid the cost of recycling the lithium-ion battery packs once they have reached the end of their useful life.

RBRC™, RIDGID®, and other battery suppliers have developed programs in the USA and Canada to collect and recycle rechargeable batteries. Normal and rechargeable batteries contain materials that should not be directly disposed of in nature, and contain valuable materials that can be recycled. Help to protect the environment and conserve natural resources by returning your used batteries to your local retailer or an authorized RIDGID service center for recycling. Your local recycling center can also provide you with additional drop off locations.

RBRC™ is a registered trademark of the Rechargeable Battery Recycling Corporation.

**For EC countries:** Defective or used battery packs/batteries must be recycled according to the guideline 2006/66/EC.

**Chart 1 Troubleshooting**

<b>PROBLEM</b>	<b>PROBABLE FAULT LOCATION</b>	<b>SOLUTION</b>
Camera video image not seen.	No power to SeeSnake.	Check power is correctly plugged in or battery is charged.
	Connections faulty.	Check switch on on DVD <i>Pak</i> . Check SeeSnake System Cable connections to DVD <i>Pak</i> and reel.
	Display set to wrong source.	Check seating, and pins in SeeSnake connection. Set-up as described in Video Display Set-up.
	Batteries Low.	Recharge batteries or connect external power supply.
Flashing Battery Warning appears.	DVD <i>Pak</i> 18 V batteries low.	Recharge DVD <i>Pak</i> batteries. Switch to AC power (110/220VAC).

Trade Tool is an Authorized Service Centr and a Ridgid Pro Platinum distributor  
[www.tradetoolsupply.com](http://www.tradetoolsupply.com)  
 503.221.8665

Rental units available